

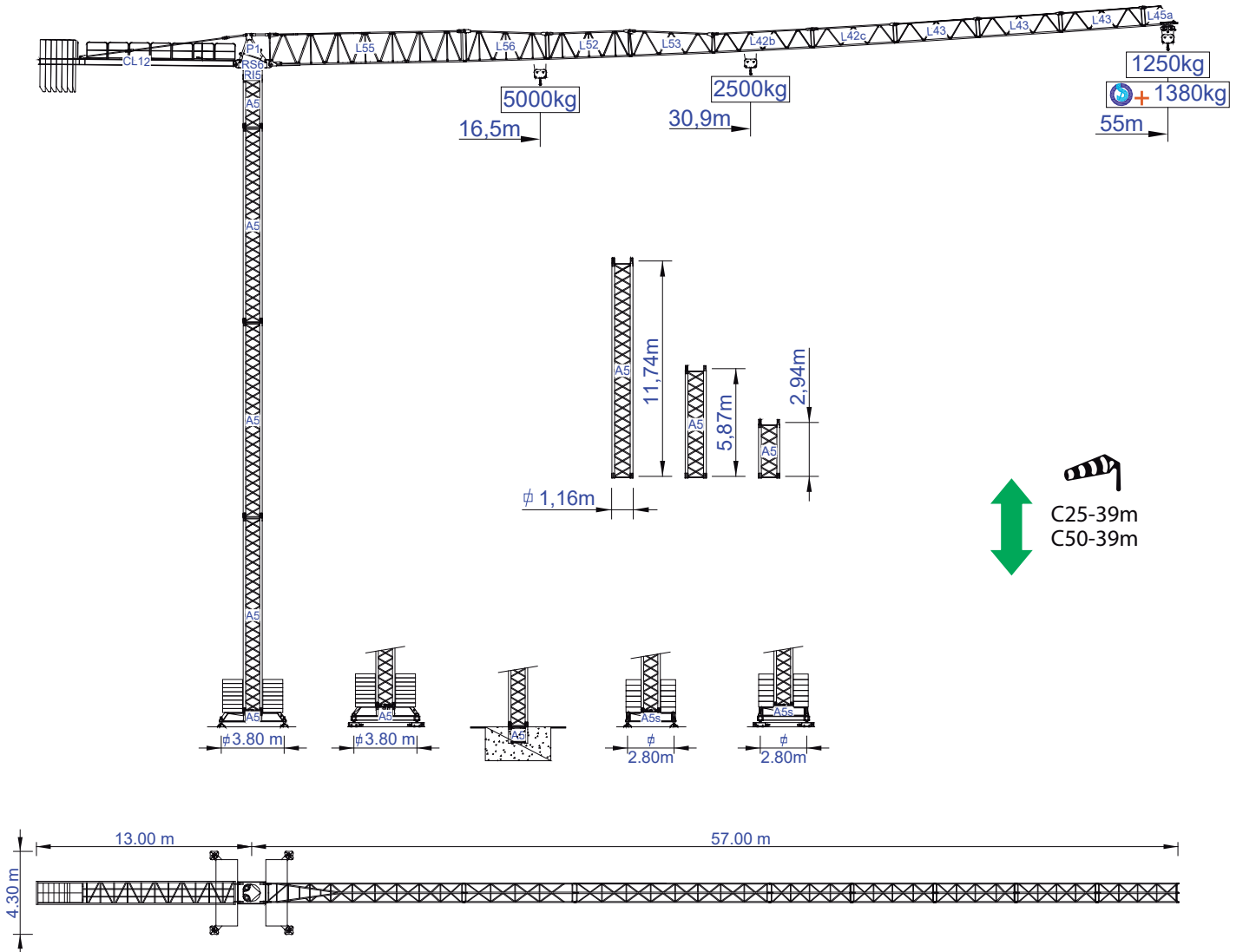

STAFFORD SOIMA TOWER CRANES

SGT 5512TL

Data Sheet / Catalogo / Fiche Technique / Scheda Dati / Dentenblatt / техническая спецификация
Metric / Métrico / Métrique / Metrico / Metrisch / метрика



Headquarters

3620 S. 40th Street, Phoenix, AZ, 85040 USA

+1 (480) 993 3302

Factory

Zona Industrial de Canas de Senhorim - EN 234, 3525-040 Canas de Senhorim - Portugal

+351 232 673 530 | info@staffordsoima.com

www.staffordsoima.com

v.2.005-08/23



Empresa certificada no âmbito da Conceção, Fabrico e Serviço Pós-venda de Gruas Soima e componentes

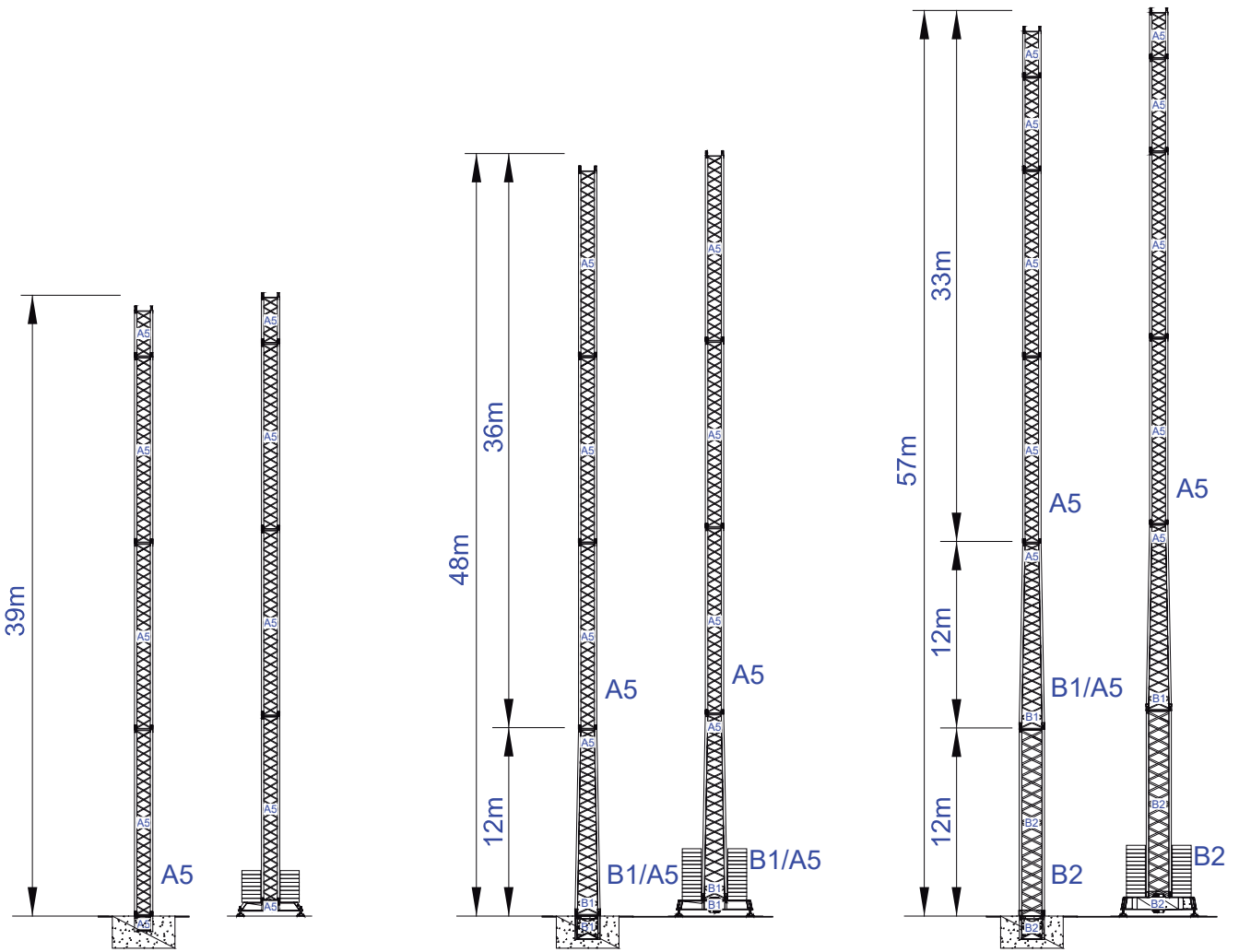

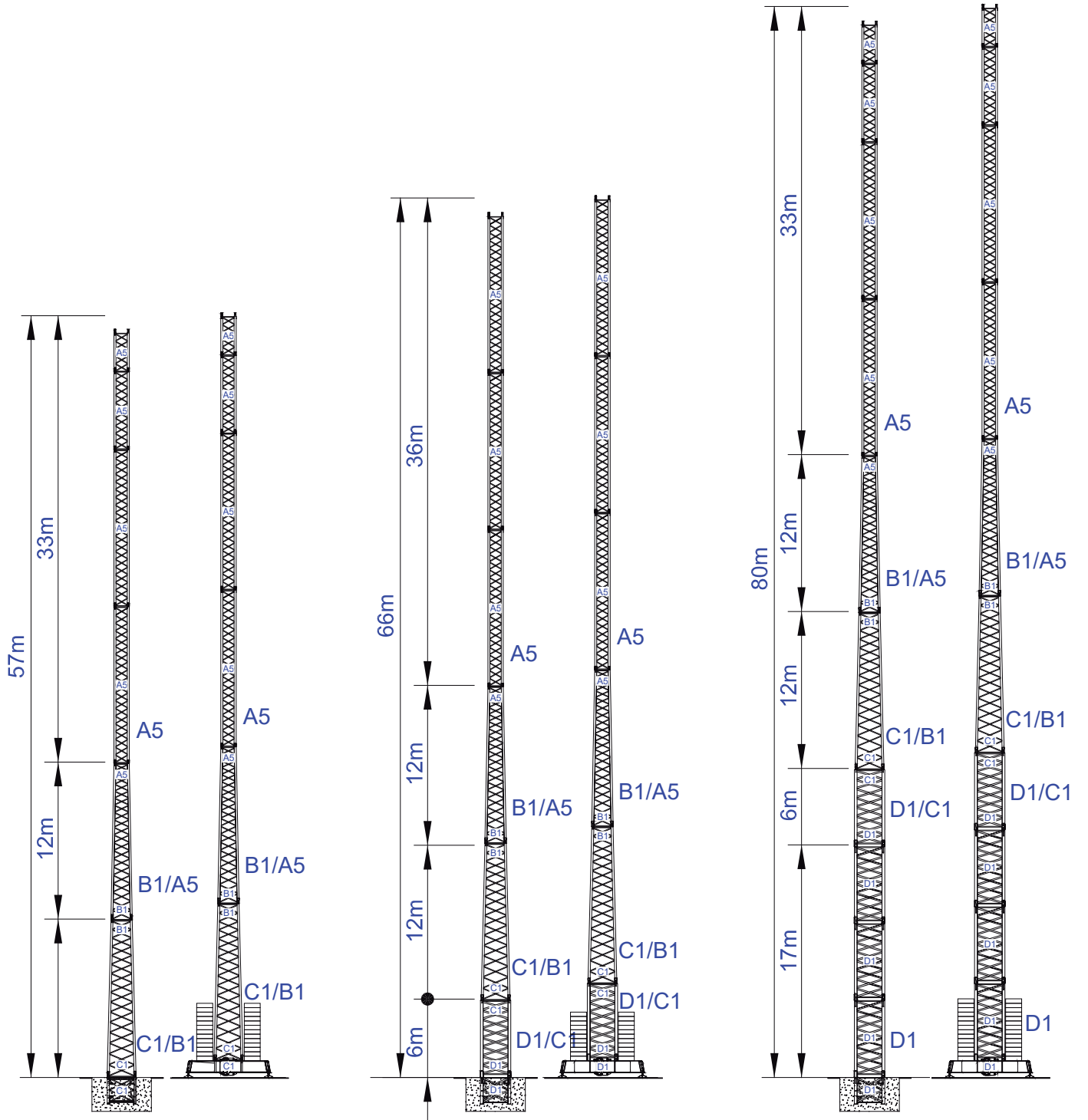



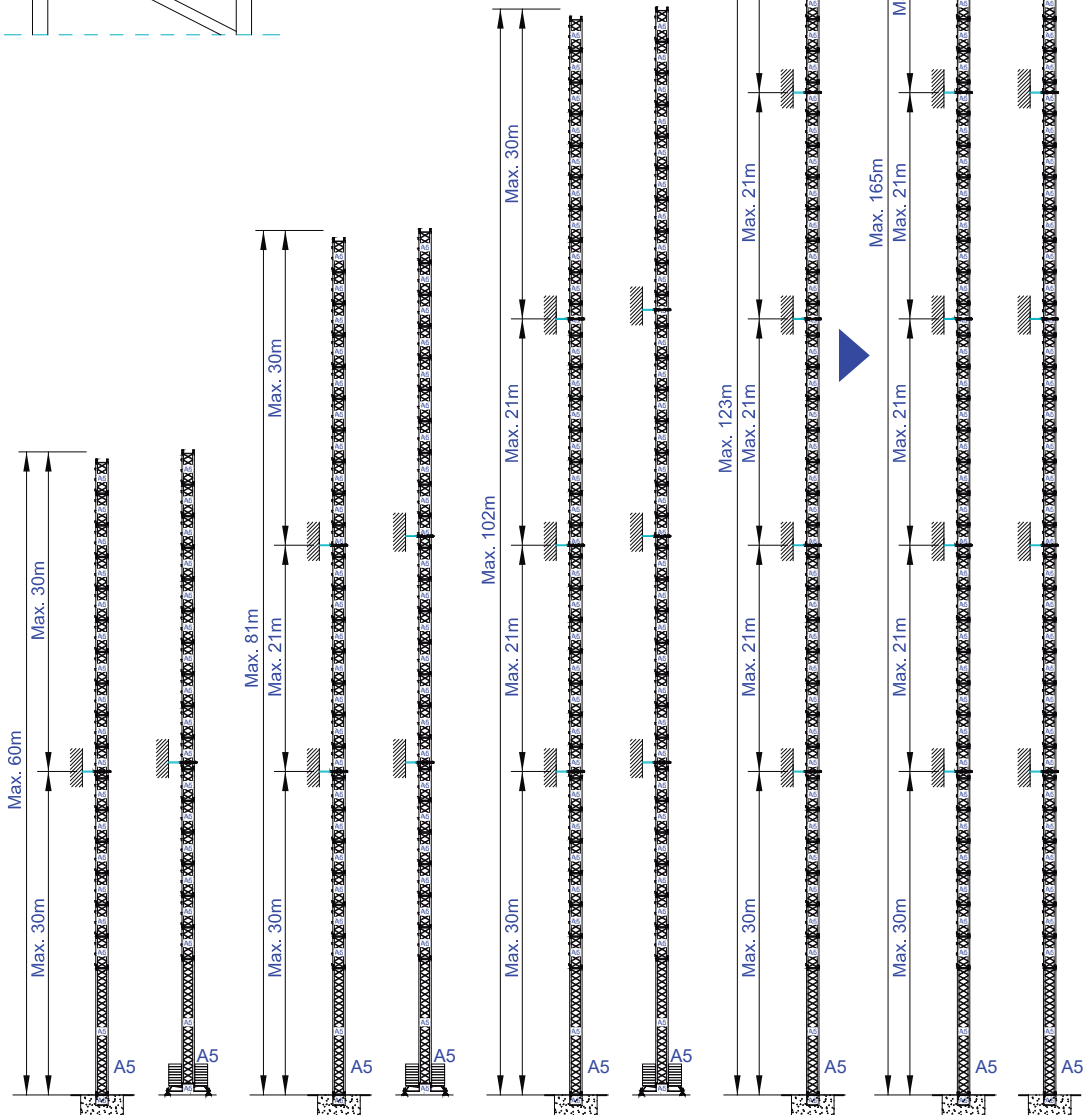
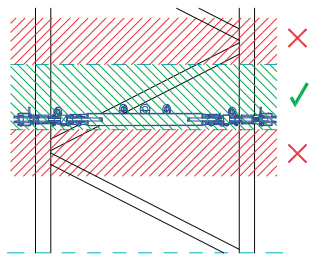
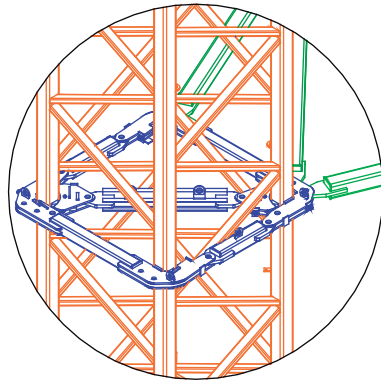

C25

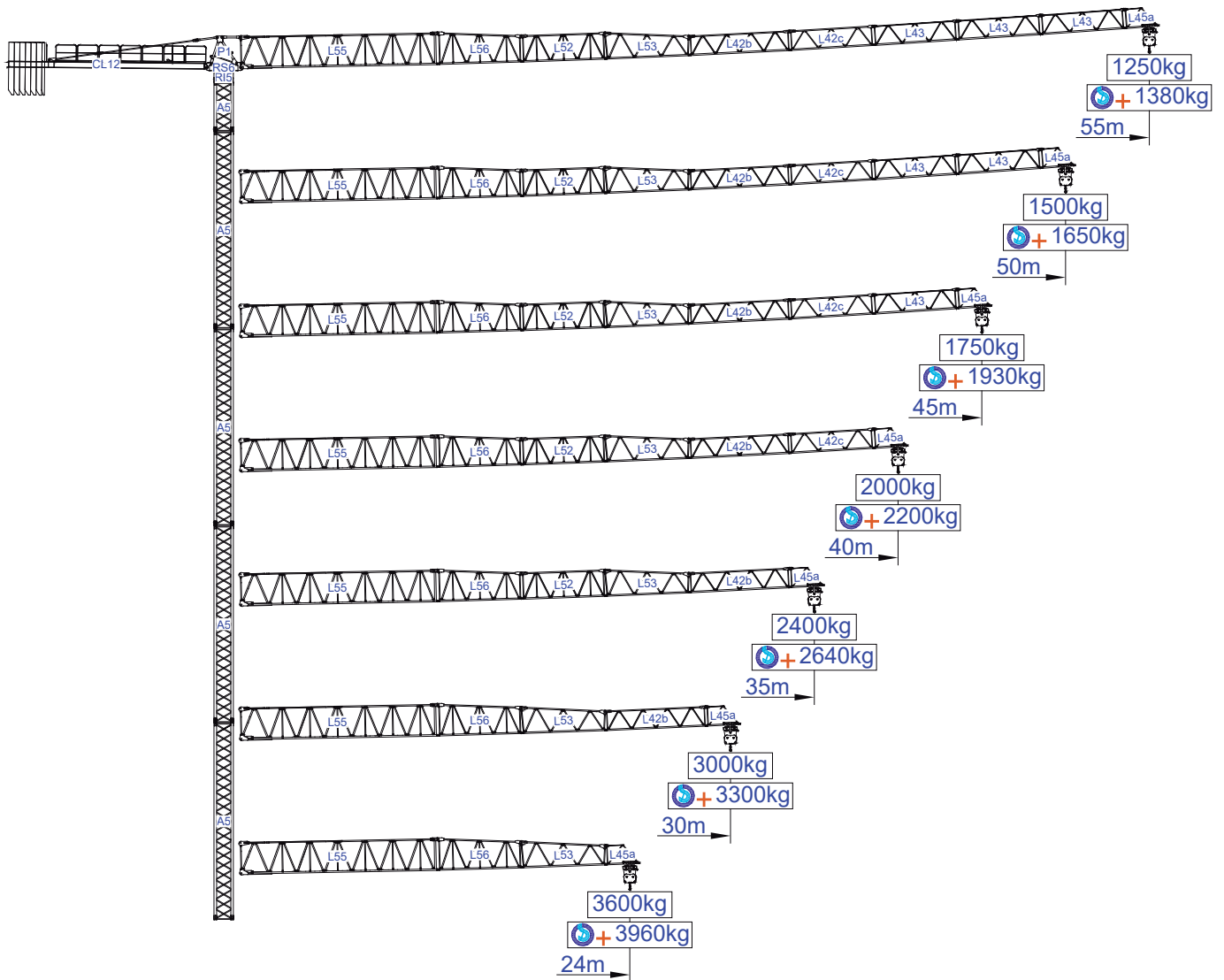



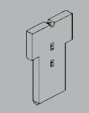





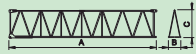

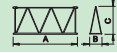
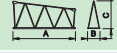
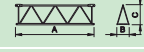
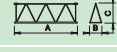
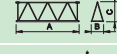



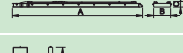

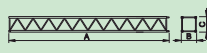
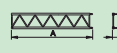
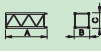
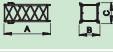

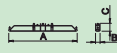

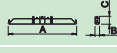



m				10	15	18	24	30	35	40	45	50	55	m
		5000kg	2500kg											
55	13000kg 6x2000kg + 1x1000kg	16,4	30,9	2500	2500	2500	2500	2500	2380	2040	1770	1550	1380	
				5000	5000	4990	3650	2840	2380	2040	1770	1550	1380	
50	13000kg 6x2000kg	17,3	32,5	2500	2500	2500	2500	2500	2500	2160	1880	1650		
				5000	5000	5000	3850	3000	2520	2160	1880	1650		
45	11000kg 5x2000kg + 1x1000kg	17,7	33,2	2500	2500	2500	2500	2500	2500	2210	1930			
				5000	5000	5000	3950	3080	2590	2210	1930			
40	10000kg 5x2000kg	17,6	33,0	2500	2500	2500	2500	2500	2500	2200				
				5000	5000	5000	3930	3060	2570	2200				
35	9000kg 4x2000kg + 1x1000kg	18,0	33,8	2500	2500	2500	2500	2500	2500					
				5000	5000	5000	4030	3150	2640					
30	8000kg 4x2000kg	18,8	35,3	2500	2500	2500	2500	2500						
				5000	5000	5000	4220	3300						
24	6000kg 3x2000kg	17,7	33,3	2500	2500	2500	2500							
				5000	5000	5000	3960							



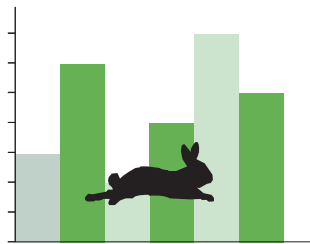

			A (mm)	B (mm)	C (mm)	kg (±5%)	
Jib / Lança / Fleche / Braccio		L55	11950	1210	2600	3100	
/ Ausleger / кливер		L56	5200	1160	1930	590	
		L52	5200	1160	1650	535	
		L53	5200	1160	1650	510	
		L42b	6080	1160	1210	520	
		L42c	5180	1160	1210	370	
		L43	5100	1160	1210	3x260 780	
		L45a	2100	1160	1210	120	
	Head turntable		RS6 RI5	2250	1350	2050	2640
		P1	1660	1220	1720	720	
Counter-jib / Contra lança / Contre-flèche		CL12	12000	1250	560	2560	
Counterweight / Contrapeso / Contrepoids / Gegengewicht / Противовес		CP2	1160	330	3140	6x2000 12000	
		CP3	1160	165	3140	1x1000 1000	
Tower section / torre / Coupe tour / Sezione torre / Turmabschnitt / Секция башни		A5	11985	1160	1160	3080	
		A5	6075	1160	1160	1660	
		A5	3120	1160	1160	990	
Climbing tower section		A5	3090	1385	1385	1040	
Foundation anchor / Tramo encastrar /		A5	1275	1160	1160	450	
Base Chassis		A5	5530	500	820	1250	
			2270	360	820	2x635 1270	
						TOTAL	2520
Base Chassis		A5s	4110	500	820	1150	
			1955	360	820	2x580 1160	
						TOTAL	2310

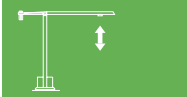

	
	0 a 1 r.p.m. 2x4 daN.m
	0 a 60 m/min 3 kW
	15 m/min 2x3 kW

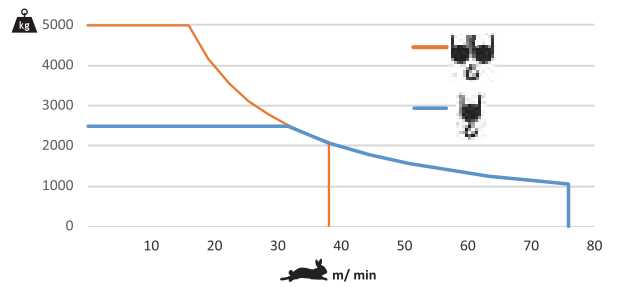



		
	0 a 78 m/min	15 kW



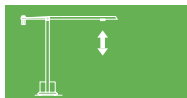

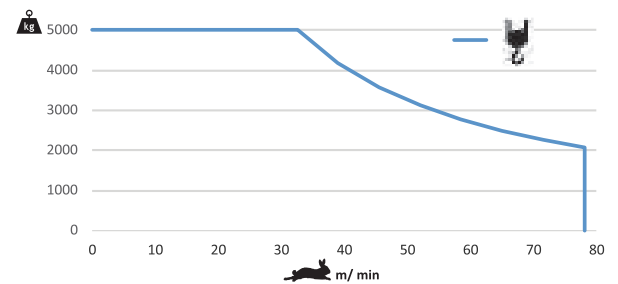
	30 kVA
	400 V +- 5% (50/60 Hz)

		
	0 a 78 m/min	30 kW



	55 kVA
	400 V +- 5% (50/60 Hz)

Max height of hoist

 (H)Max. 132m + 

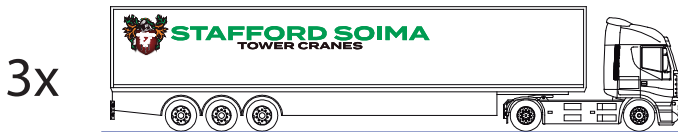
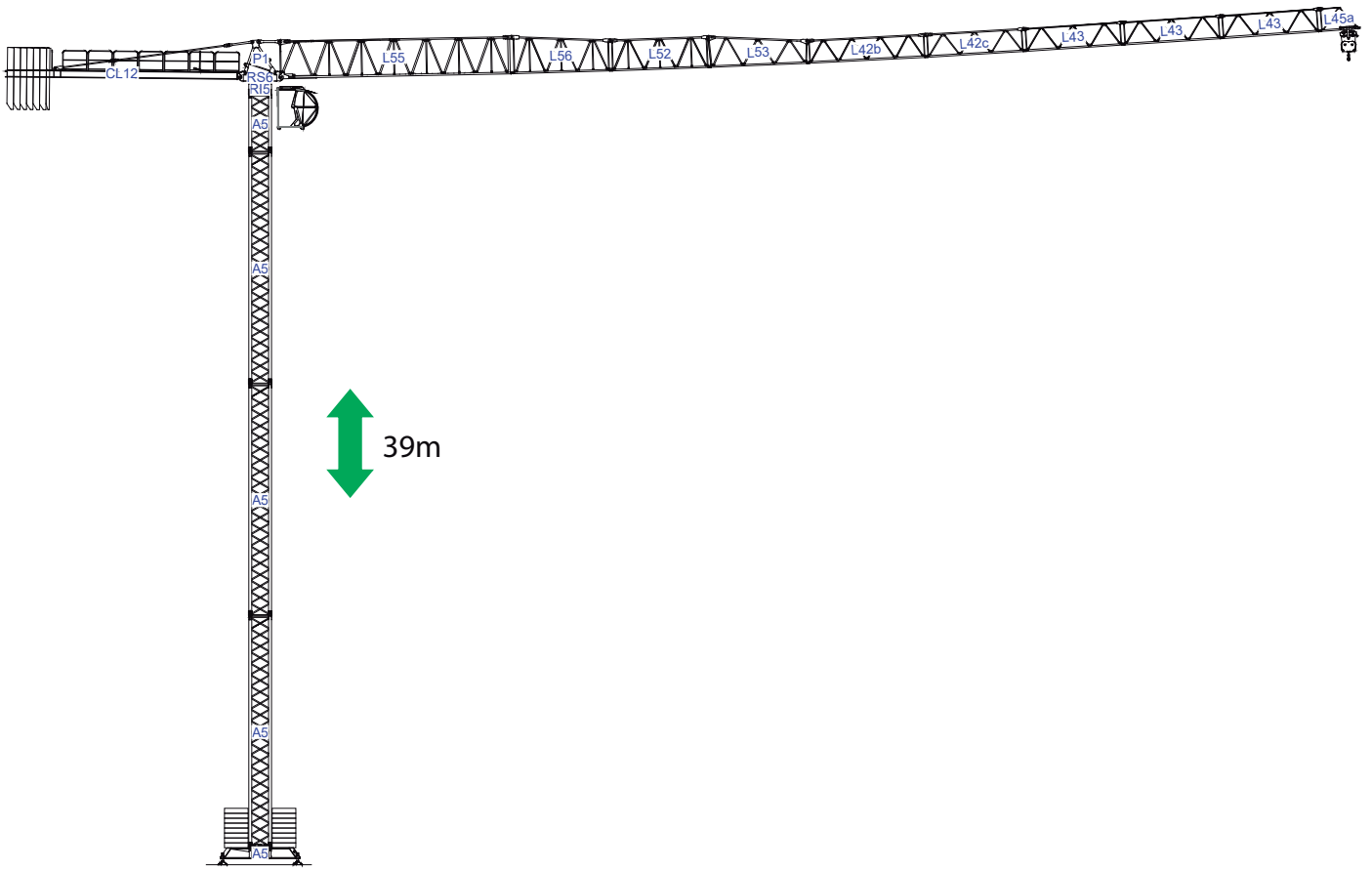

/ 3x

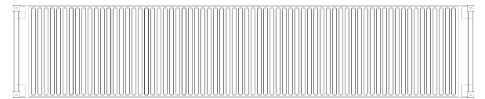

1

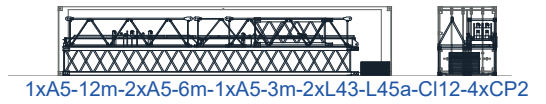
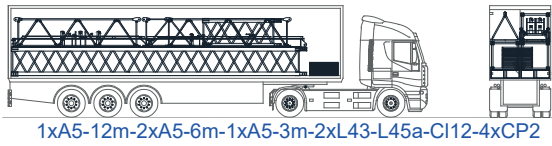

2

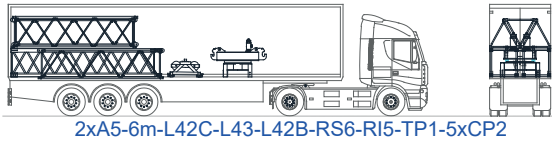

3

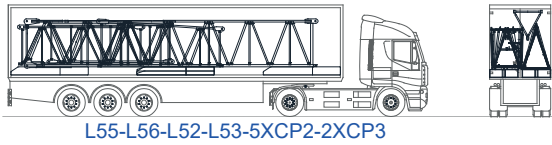

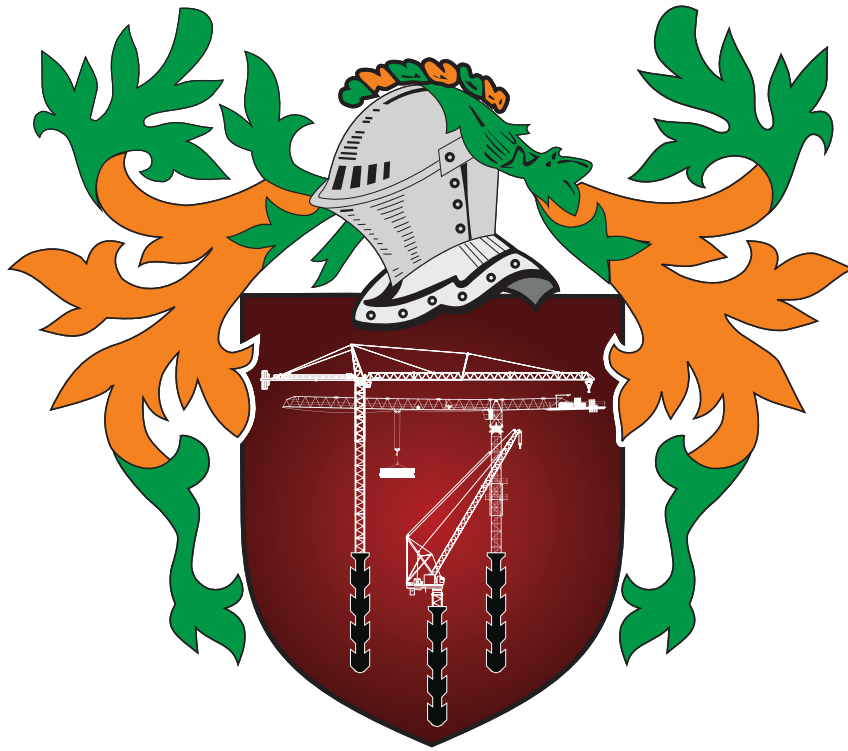

STAFFORD SOIMA

TOWER CRANES

STAFFORD SOIMA, SA

Headquarters

 3620 S. 40th Street , Phoenix , AZ, 85040 USA

 +1 (480) 993 3302

Factory

 Zona Industrial de Canas de Senhorim - EN 234, 3525-040 Canas de Senhorim - Portugal

 +351 232 673 530  info@staffordsoima.com

 staffordsoima.com